



# LINEA BAGNO



ST01 1705

### NEAT MATIC TRASPARENTE

Distributore automatico carta asciugamani con rotolo di riserva. Taglia automaticamente la carta porzionando asciugamani da cm. 20x25. Realizzato in ABS e materiali compositi. Ingombro cm. 31x31x22,5 h.



CE02 5130

### ROLL MATIC 3 V

Carta asciugamani in rotolo. Microincollata 3 veli gr. 52 mq. mt. 160 in pura cellulosa, senza pretaglio (640 strappi 20x25 scatole da 8 rotoli)



ST01 1700

### NEAT MATIC BIANCO

Distributore automatico carta asciugamani con rotolo di riserva. Taglia automaticamente la carta porzionando asciugamani da cm. 20x25. Realizzato in ABS e materiali compositi. Ingombro cm. 31x31x22,5 h.

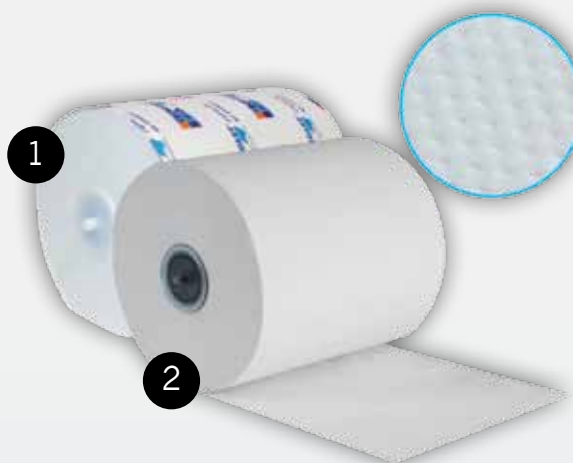

CE02 5131

### 1 - ROLL MATIC FASCETTATO 3 V

Carta asciugamano in rotolo 3 veli micro incollato fascettato sigolarmente in pura cellulosa, senza pretaglio (scatole da 8 rotoli).

CE02 5125

### 2 - HANDTOWEL ROLUX 2 V C/ANIMA

Carta asciugamani in rotolo. Microincollata 2 veli gr. 37 mq. mt.200 in pura cellulosa, senza pretaglio (scatole da 8 rotoli).



J001 1500

### VISIOPAPER AUTOMATICO B

Distributore per carta asciugamano a rotolo .Con sistema automatico meccanico di taglio carta e definizione della porzione di carta. Per rotolo HANDTOWEL SUPERP300.  
Ingombro cm. 29x25x40,5 h.



CE02 5121

### HANDTOWEL SUPER P300

Carta asciugamano cellulosa 2 veli da mt.300 s/pretaglio peso 1,985 kg/ cad.  
Confezione termoretraibile da 6 rotoli.



NT01 1000

### NEAT SYSTEM NO TOUCH

Dispenser elettronico per asciugamano in rotolo con fotocellula funzionante a batteria (4 x RL20 1 TORCIA) in abs bianco antiurto . Possibilità di regolazione porzione carta e tempo di erogazione. Ingombro cm. 29,7x21x35 h.



ST02 5136

### IDRO ROLL 3V

Carta asciugamano a rotolo pura cellulosa 3 v morbida e trattata idrosolubile da gr. 54 mq. Rotolo da 90 mtl ca da utilizzare tramite dispenser NEAT SYSTEM NO TOUCH. Scatola da 6 rotoli.



ST02 5137

### IDRO ROLL 3V AZZURRO

Carta asciugamano a rotolo pura cellulosa BLU 3 v morbida e trattata idrosolubile PER ALIMENTI da gr. 57 mq . Rotolo da 88 mtl ca da utilizzare tramite dispenser NEAT SYSTEM NO TOUCH. Scatola da 6 rotoli.

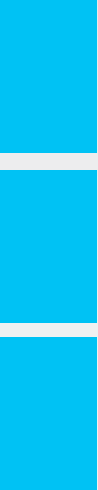

ST01 1600

**RICO HAND SENSOR DISPENSER**

Dispenser elettronico per asciugamano in rotolo con fotocellula funzionante a batteria (4 x RL20 1 TORCIA) in ABS bianco antiurto. Possibilità di regolazione porzione carta e tempo di erogazione. Usare carta HAND TOWEL SUPER P300 C/ANIMA. Ingombro cm. 32,2x23x33 h.



CE02 5122

**HANDTOWEL SUPER P300 C/ANIMA**

Carta asciugamano cellulosa 2 veli con animella da mt.300 s/pretaglio peso 1,985 kg/cad (si può utilizzare per Visiopaper protetto e RICO HAND SENSOR). Confezione termoretraibile da 6 rotoli.



J001 1625

**VISIOPAPER CONTINUO PROTETTO - T**

Distributore semiautomatico con leva idrorepellente. Avanzamento carta manuale (10 cm alla volta). Realizzato in ABS e materiali compositi. Ingombro cm. 29x25x36,5 h.



J001 1620

**VISIOPAPER CONTINUO PROTETTO - B**

Distributore semiautomatico con leva idrorepellente. Avanzamento carta manuale (10 cm alla volta). Realizzato in ABS e materiali compositi. Ingombro cm. 29x25x36,5 h.



J001 1510

### NEW VISIOPAPER BIANCO

Distributore per carta asciugamani a rotolo. Funzionamento a leva che eroga la porzione di carta. Per rotolo HANDTOWEL. Ingombro cm. 30,5x26x36 h.



CE02 5120

### HANDTOWELROLUX 2 V

Carta asciugamani in rotolo. Microincollata 2 veli gr. 37 mq. mt. 200 in pura cellulosa, senza pretaglio (scatole da 8 rotoli) per VISIOPAPER LIBERO.

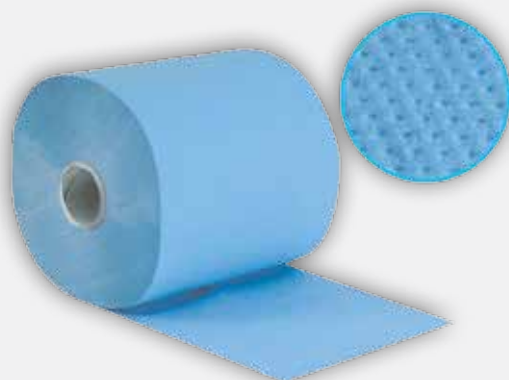

CE02 5123

### HANDTOWELROLUX 2 V AZZURRO

Carta asciugamani in rotolo. Microincollata 2 veli gr. 50 mq. mt. 200 in pura cellulosa, senza pretaglio (scatole da 8 rotoli) per VISIOPAPER LIBERO.



AL01 1500

### LIBERTY

Distributore carta asciugamani in rotoli ad avanzamento controllato. Realizzato in ABS e materiali compositi. Ingombro cm. 27x21,8x29 h.



AL01 1505

### LIBERTY MASCH. VERDE T

5



AL01 1555

### LIBERTY T BLU

Personalizzazione Liberti con minimo d'ordine.



AL01 1565

### LIBERTY T VERDE

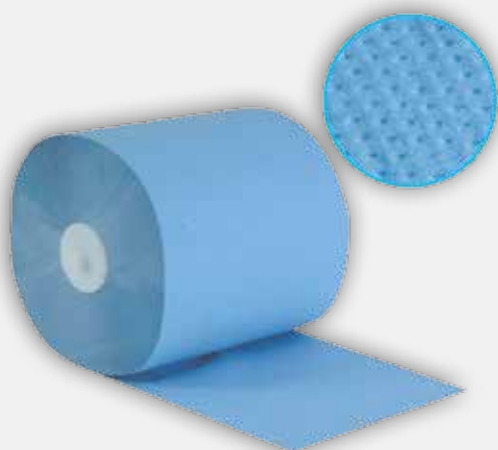

CE02 5124

### SL ROLL 2 V AZZURRO

Carta asciugamani in rotolo. Microincollata 2 veli gr. 52 mq. mt. 160 in pura cellulosa, senza pretaglio (640 strappi 20x25 scatole da 8 rotoli).



LR02 5121

### SL ROLL 2 V

Carta asciugamani in rotolo, 2 veli gr. 50 mq. mt. 300 (kg. 1,5 a rotolo) in pura cellulosa, senza pretaglio (scatole da 8 rotoli).

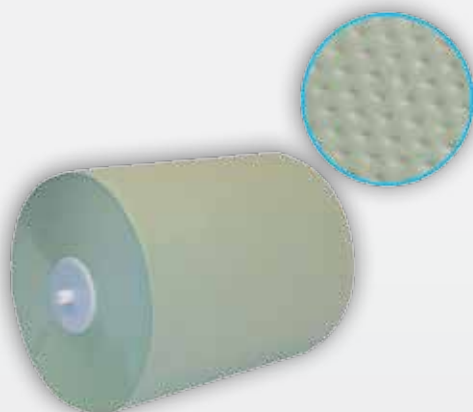

CE02 5126

### SL ROLL 2 V VERDE

Carta asciugamani in rotolo. Micro incollato a 2 veli gr. 50 mq. mt 120 in pura cellulosa senza pretaglio (scatole da 8 rotoli).



CE02 5127

### ASCIUGONE 3 V

Carta asciugamano 3 veli incollati in pura cellulosa con pretaglio cm. 24x22, 57 mt. (confezione da 12 rotoli).



LR02 5127

### ASCIUGHINO 2 V

Carta asciugamano 2 veli in pura cellulosa con pretaglio cm. 24x22, 61 mt. (confezione da 12 rotoli).



MA01 1515

### PRESTIGE T/BIANCO

Distributore asciugamano per carta asciugamano rotolo e salvietta piegata in abs bianco e coperchio trasparente azzurrato per DOMUS e ASCIUGHINO /ASCIUGONE. Ingombro cm. 30x25x30 h.



LR02 5102

### CARTA CRESPATA MONOVELO

Rotolo asciugamano carta crespata con anima cm. 4 gr. 40 mq. cm. 22x100 mt. (scatole da 12 rotoli) per distributori elettronici ed automatici.



LR02 5126

### 1 - DOMUS 2 V

Carta asciugamani in rotolo in pura cellulosa, 2 veli gr. 44 mq. Cm. 22x115 mt. Kg. 1 (scatola da 12 rotoli).

LR02 5116

### 2 - DOMUS 1 V

Carta asciugamani in rotolo in pura cellulosa, 1 velo gr. 30 mq. Cm. 22x140 mt. Kg. 1 (scatola da 12 rotoli).

LR02 5108

### 3 - DOMUS 2 VC

Carta asciugamani in rotolo in pura cellulosa, 2 veli gr. 30 mq. Cm. 22x121 mt. Kg. 0,8 (scatola da 12 rotoli).

MA01 1550

### DISPENSER KOMPATTO ASCIUGAMANI

Dispenser distributore automatico per rotoli TNT rinforzato con riavvolgimento automatico. Realizzato in ABS e metallo. Ingombro cm. 38,5x26,5x48,5 h.



ST02 1910

### CARTA SOFTY

Rotolo asciugamano TNT rinforzato (tipo stoffa) larg. cm. 20 x 40 mt. (confezioni da 6 rotoli).







QT01 1110

### HAND SNAIL DISPENSER B

Distributore carta asciugamano in ABS bianco con strozzatura regolabile.  
Eroga in modo controllato porzioni di carta.  
Rotolo max diam. cm. 20,5x24 h.  
Ingombro cm.24,5x22x37 h.



PD02 5180

### HAND TOWEL SNAIL

Carta asciugamano a rotolo pura cellulosa microgofrata a spirale per distributore HAND SNAIL DISPENSER mtl 180 486 strp. cm. 21,5 h.  
Confezione da 6 rotoli.



ST01 1535

### BOX MAXI FUMÈ

Distributore carta asciugamani in rotoli ad estrazione a spirale. Realizzato in ABS.  
Ingombro cm. 27x24x34 h.



LR02 5220

### 1 - SG

Carta asciugamani in rotolo spirale, 2 veli gr. 42 mq. kg. 2 (confezione da 6 rotoli).

LR02 5222

### 2 - SM

Carta asciugamani in rotolo spirale, 2 veli gr. 42 mq. kg. 1,5 (confezione da 6 rotoli).

LR02 5224

### 3 - SP

Carta asciugamani in rotolo spirale, 2 veli gr. 42 mq. kg. 0,8 (confezione da 12 rotoli).



ST01 1116

#### LONDON P.A.C. HIGH TECH SATINATO

Distributore ABS satinato grigio per carta asciugamano salvietta piegata a "C" o a "V". Ingombro cm. 28x14x40 h.



ST01 3507

#### LONDON 1000 C HIGH TECH SATINATO

Distributore di sapone a cartuccia di sapone liquido in ABS satinato grigio. Ingombro cm 12x10x25 h.



ST01 2206

#### DISTRIBUTORE CARTA IGIENICA INTERCALATA HIGH TECH SATINATO

Distributore in ABS satinato grigio per carta igienica intercalata a foglietti. Ingombro cm. 14x11,5x32 h.



ST01 2526

#### DISTRIBUTORE LONDON MINI HIGH TECH SATINATO

Distributore carta igienica minijumbo per rotoli medi (jumbo mini) in materiale ABS satinato grigio. Ingombro cm. 27x12x 25,5 h.



ST01 6507

#### DISTRIBUTORE CARTA COPRI WC HIGH TECH SATINATO

Distributore carta copri Wc in ABS satinato grigio. Ingombro cm. 21,5x6x27 h.



ST01 6307

#### DISTRIBUTORE SACCHETTI IGIENICI HIGH TECH SATINATO

Distributore per sacchetti igienici in ABS satinato grigio. Ingombro cm. 14x5,5x29 h.



SH01 1312

### HAND TOWEL ROLL DISPENSER ALLUMINIO

Distributore in alluminio e ABS per carta asciugamano a rotolo. Erogazione automatica con fotocellula, taglio manuale a seghetto. Ingombro cm. 32,5x22x42 h.



SH02 5322

### ROTOLO ASCIUGAMANO FASCETTATO TAD

Carta asciugamano a rotolo in pura cellulosa 2 v. Da utilizzare su HAND TOWEL ROLL DISPENSER. Cartone da 6 rotoli.



SH01 1310

### DISPENSER ALLUMINIO ASCIUGAMANO INTERCALATO

Distributore in alluminio e ABS per salviette asciugamano. Ingombro cm. 27,6x11x48,5 h.



SH02 5327

### SALVIETTA SOFT 2V TAD

Carta asciugamano a salvietta di pura cellulosa soffice 2v cm. 21,2x34. Cartone da 21 pacchi da 110 pezzi. Totale 2310 pz.



SH02 5329

### SALVIETTA EXTRA SOFT 2V TAD

Carta asciugamano a salvietta pura cellulosa extra soffice 2v cm. 21,2x34. Cartone da 21 pacchi da 100 pezzi. Totale 2100 pz.



SH01 3690

### DISPENSER ALLUMINIO SAPONE SCHIUMA CON FOTOCELLULA

Distributore in alluminio e ABS per cartuccia sapone a SCHIUMA. Ingombro cm. 12,9x12,5x29,3 h.



SH04 3042

### SOAP FOAM LUXURY ML 800

Sapone schiuma Premium in bag da ml. 800 c/ tettarella. Cartone da 4 bags.



SH01 3890

### DISPENSER ALLUMINIO SAPONE LIQUIDO IN CARTUCCIA

Distributore in alluminio e ABS per cartuccia sapone liquido. Ingombro cm. 10,5x10,2x29,7 h.



SH04 1030

### SOAP LIQUIDO DELICATO ML. 1000

Sapone liquido in flacone da ml. 1000 per distributore DISTR. SAPONE LIQUIDO CARTUCCIA. Cartone da 6 flaconi.



SH01 2310

### DISPENSER ALLUMINIO IGIENICA INTERCALATA

Distributore in alluminio e ABS per carta igienica intercalata. Ingombro cm. 15,3x11,7x28,4 h.



CE03 5320

### NEAT PACK

Carta igienica a salvietta interfogliata incollata 2 veli di pura cellulosa cm. 11x18,5. Scatola da 36 fasce per 250 pezzi totale 9000 salviette.



SH01 2610

### DISPENSER ALLUMINIO IGIENICA MINIJUMBO

Distributore in alluminio e ABS per carta igienica minijumbo. Può contenere il rotolo di carta igienica di riserva. Ingombro cm. 31,6x12,8x26,9 h.



LR03 5075

### ADVANCED IGIENICA MINIJUMBO

Carta igienica minumbo in pura cellulosa 2v mtl.170 - peso gr. 550 - anima 6 cm. per rotolo. Confezione termoretraibile da 12 rotoli.



SH01 6120

### DISPENSER ALLUMINIO PORTA VELINE

Distributore in alluminio e abs da tavolo per veline cosmetiche intercalate.  
Ingombro cm. 25,5x6,2x13 h.



SH08 3110

### PREMIUM VELINE COSMETICHE

Veline cosmetiche intercalate in pura cellulosa  
2v cm. 21x20. Cartone da 36 scatoline da 100 pz.  
Totale 3600 pz.



SH09 0040

### CESTO ALLUMINIO LT 40

Cesto gettacarta in alluminio e ABS senza base  
d'appoggio (da appendere a muro).  
Ingombro cm. 37,3x19,3x67,8 h.



SH09 9040

### BASE IN PLASTICA PER CESTO

Base in materiale plastico da utilizzarsi per  
appoggio CESTO.





AM01 1160

### DISPENSER MODULAR ASCIUGAMANO PIEGATO

Distributore carta asciugamano piegata.  
Realizzato in ABS bianco e azzurro.  
Ingombro cm. 29x14,5x42,5 h.



AM01 2520

### DISPENSER MODULAR JUMBO SMALL

Distributore bianco e azzurro per carta igienica  
rotolo JUMBO MINI.  
Ingombro cm. 22x14,5x27,5 h.



LR03 5060

### JUMBO MINI SMALL

Carta igienica a rotoli minijumbo in cellulosa  
doppio velo gofrata con pretaglio in confezioni  
da 8 rotoli minijumbo da kg. 0,600 ca. cad.



AM01 2405

### DISPENSER MODULAR IGIEN FOLD

Distributore bianco e azzurro per carta igienica a  
foglietti. Ingombro cm. 15x13x27,5 h.



BF01 3000

H.A.C.C.P.

### COLONNA MOBILE PORTA DISPENSER IGIENIZZANTE

Colonna mobile in metallo verniciato per dispenser in abs automatico che eroga igienizzante. Adatta per industrie alimentari, laboratori, pasticcerie etc. Ingombro diametro base cm. 40 x altezza cm. 140.

AM01 3050

### DISPENSER MODULAR ELETTRONICO

Distributore per sapone liquido a riempimento da ml. 1000, in materiale abs bianco e azzurro. Funzionante con 4 batterie stilo AA. Ingombro cm. 11,5x11,5x25 h.

AM01 3060

### DISPENSER MODULAR SOAP LT. 0,8

Distributore per sapone liquido/crema in materiale ABS bianco e azzurro ricarica a sacche da ml. 800. Ingombro cm. 11,5x11,5x25 h.

SM04 3080

### CREMANI 1000 DOVER ML. 800

Crema di sapone liquido in sacche da ml. 800 colore rosa shocking e gradevole profumo. Cartone da 6 sacche.





AM01 3303

#### DISPENSER MINI MODULAR SOAP S

Distributore x sacche da lt. 0,4 per sapone in crema/liquido in materiale ABS bianco e azzurro. Ingombro cm. 9x9,8x19 h.



SM04 3040

#### CREMANI 1000 DOVER ML. 400

Crema di sapone liquido in sacche da ml. 400 colore rosa shocking e gradevole profumo. Cartone da 10 sacche.



AM01 3080

#### DISPENSER MODULAR FOAM

Distributore per sapone in SCHIUMA in materiale ABS bianco e azzurro, ricarica in sacche da ml. 800. Ingombro cm. 11,5x11,5x25 h.



SM04 3082

#### CREMANI FOAMER

Sapone liquido che sviluppa SCHIUMA in sacche da ml. 800 con gradevole profumo. Cartone da 6 sacche.



AM01 3070

#### DISPENSER MODULAR SPRAY

Distributore per sapone SPRAY in materiale ABS bianco e azzurro, ricarica in sacche da ml. 800. Ingombro cm. 11,5x11,5x25 h.



SM04 3084

### CREMANI SPRAY ROSA

Sapone liquido SPRAY in sacche da ml. 800 colore rosa con gradevole profumo di lavanda. Cartone da 6 sacche.



SM04 3086

### CREMANI SPRAY INODORE

Sapone liquido SPRAY in sacche da ml. 800 colore bianco SENZA profumo. Cartone da 6 sacche.



AM01 3300

### DISPENSER MINI MODULAR SOAP R

Distributore a rabbocco da lt. 0,4 per sapone in crema/liquido in materiale ABS bianco e azzurro. Ingombro cm 9x9,8x19 h.



AM01 3003

### DISPENSER MINI MODULAR SPRAY WC

Distributore a rabbocco da lt. 0,4 per detergente SPRAY per ciambella WC in materiale ABS bianco e azzurro. Ingombro cm. 9x9,8x19 h.

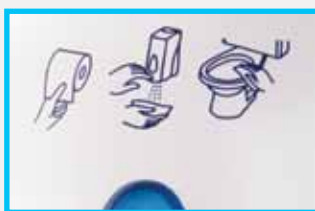

AM01 3005

### DISPENSER MINI MODULAR SPRAY WC SACCA

Distributore x sacca da lt. 0,4 per detergente SPRAY per ciambella WC in materiale ABS bianco e azzurro. Ingombro cm. 9x9,8x19 h.

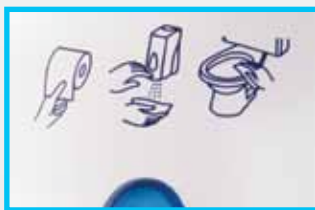



IN11 0072

H.A.C.C.P.

### AF200 TOILETTE DISINFETTANTE

Igienizzante alcoolico per ciambella in flaconi da litri 2 (cartone da 4 flaconi). Utilizzabile per ciambella Masterpiece e/o distributori MINIMODULAR WC R.



SM11 0073

H.A.C.C.P.

### AF200 SANIFICANTE ML. 400

Liquido alcoolico igienizzante spray in sacche da ml. 400. Cartone da 10 sacche. Da utilizzare in MINIMODULAR SPRAY DISPENSER WC SACCA.



AM01 6070

### MODULAR PORTA SACCHETTI IGIENICI

Distributore per sacchetti igienici mod. Igien Bag. Ingombro cm. 9,5x3x13,5 h.



AM09 0045

### MODULAR CESTINO GETTACARTA A PARETE

Cestino gettacarta a parete in ABS bianco e azzurro. Ingombro cm. 33,5x23x65 h.



ST01 1107

### M P.A.C. BLU

Distributore bianco e blu per carta asciugamano a salvietta piegata a C e a V.  
Ingombro cm. 29,8x15,5x38 h.



ST01 2507

### M TOP BLU

Distributore in ABS bianco e blu per rotoli carta igienica jumbo con caricamento laterale.  
Ingombro cm. 31,2x12x31,2 h.



ST01 3582

### M COL BLU

Distributore a cartuccia bianco e blu per sapone da ml. 800. Ingombro cm. 8,3x9,4x25,5 h.



ST04 1108

### SM COL

Detergente liquido in crema ph neutro profumato. Contenuto ml. 800. Ricarica per M COL (confezione da 6 flaconi).



ST01 1105

### LONDON P.A.C. T

Distributore trasparente carta asciugamani a salviette. Piegate a C ed a V. Realizzato in ABS. Ingombro cm. 28x14x 40 h. Capacità 450 salviette circa.

PA02 5312

#### 1 - C. FOLD 25X33 EXTRA

Salvietta asciugamano piegata a C cm. 25x33 in pura cellulosa monovelo extra bianco 43 gr. al mq. (scatole da 3840 salviette).



PA02 5310

#### 2 - C. FOLD 23X31 EXTRA

Salvietta asciugamano piegata a C cm. 23x31 in pura cellulosa monovelo extra bianco 43 gr. al mq. (scatole da 3840 salviette).



PA02 7310

#### 3 - C. FOLD 23X33 BIANCO NATURALE

Salvietta asciugamano piegata a C cm. 23x33 bianco economico 43 gr. al mq. (scatole da 3840 salviette).



CE02 5314

#### 4 - C FOLD 23X33 EXTRA 2V

Salvietta asciugamano piegata a C cm. 23x33 in pura cellulosa 2 veli microincollati (cartone da 20 pacchi da 152 salviette, totale 3040 pezzi).



ST01 1100

### LONDON P.A.C. B

Distributore bianco carta asciugamani a salviette. Piegate a C ed a V. Realizzato in ABS. Ingombro cm. 28x14x40 h. Capacità 450 salviette circa.

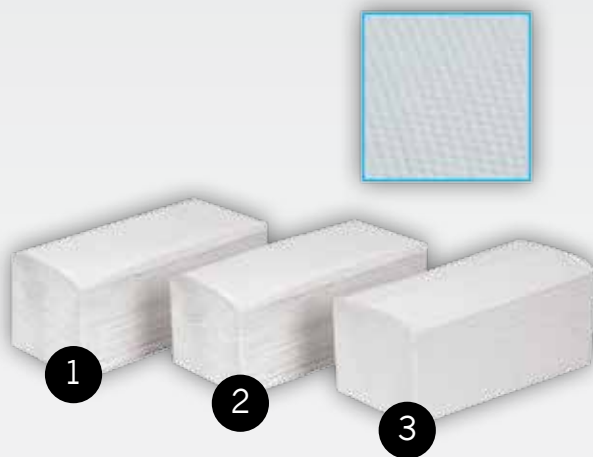

CE02 5328

**1 - OPERA 2V INTERFOGLIATA**

Salvietta asciugamano interfogliata cm. 22x32 in pura cellulosa 2 veli incollati (scatole da 3200 salviette).

CE02 5331

**2 - OPERA 3V INTERFOGLIATA**

Salvietta asciugamano interfogliata cm. 23x32 in pura cellulosa 3 veli incollati (scatole da 2500 salviette).



CE02 5334

**3 - OPERA 3V GRANDE INTERFOGLIATA**

Salvietta asciugamano interfogliata extra cm. 23x42 in pura cellulosa 3 veli incollati (scatole da 2000 salviette).



J001 1125

**Z600**

Distributore asciugamano per salviette a "V" a "C" e a "Z". Realizzato in ABS. Ingombro cm. 27,5x12x36,5 h.

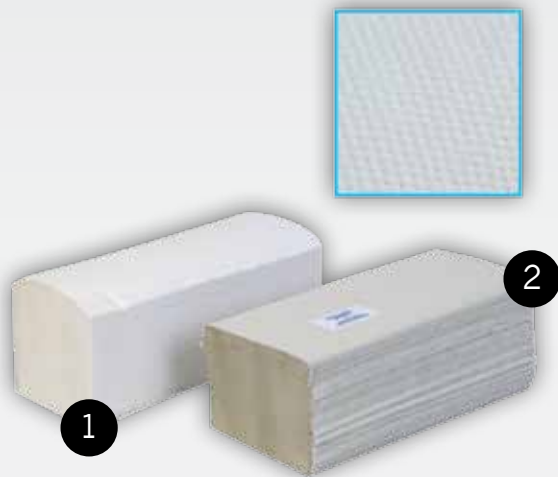

CE02 5322

### 1 - V. FOLD 25X21 EXTRA

Salvietta asciugamano piegata a "V"  
cm. 25x21 in pura cellulosa 2 veli incollati  
(scatole da 3200 salviette).

PA02 7320

### 2 - V. FOLD 24,2X22,2 BIANCO NATURALE

Salvietta asciugamano piegata a "V"  
cm. 24,2x22,2 bianco economico 43 gr. mq.  
monovelo (scatole da 5000 salviette).



CE02 5313

### V FOLD IDROSOLUBILI 22X21

Salvietta asciugamano piegata a "V" cm. 22x21  
in cellulosa idrosolubile (cartone da 15 pacchi da  
180 salviette, totale 2700 pezzi).



PA02 5324

### V FOLD PURA CELLULOSA 2 V 24X22

Salvietta asciugamano piegata a "V"  
microincollata cm. 24x22 in pura cellulosa 2 veli  
(cartone da 20 pacchi da 200 salviette, totale  
4000 pezzi).



PD02 5342

### Z FOLD 24X24 EXTRA 2V

Carta asciugamano a salvietta piegata a "Z" cm. 24x24 pura cellulosa 2v in cartone da 3750 pezzi.



SA01 1312

### DISPENSER INOX BIG TOWEL

Distributore inox per carta asciugamano a salvietta maxi. Ingombro cm. 33x12x37,5 h.



SA02 5333

### PAPER TOWEL W FOLD XL 3V

Carta asciugamano a salvietta mxi a "W" 3 veli pura cellulosa cm. 29x44 micro gofrato in cartoni da 15 confezioni da 75 pezzi. Totale 1125 pezzi. Da utilizzare su DISPENSER BIG TOWEL.





ST01 3870

### LONDON 800 ACCIAIO LUCIDO BAG IN BOX

Distributore in acciaio inox lucido a rabbocco per sapone liquido bag in box. Ingombro cm. 12x12x26,5 h.



ST01 2300

### MAXI DISPENSER ACCIAIO LUCIDO

Distributore in acciaio inox lucido per carta igienica a salvietta. Ingombro cm. 12x12x24,5 h.



ST01 6306

### DISTRIBUTORE ACCIAIO LUCIDO PER SACCHETTI IGENICI

Distributore in acciaio inox lucido per sacchetti igienici polietilenati. Ingombro cm. 12,5x4,5x28 h.



ST01 6506

### DISTRIBUTORE CARTA COPRI WC ACCIAIO LUCIDO

Distributore in acciaio inox lucido per carta copri wc. Ingombro cm. 22x5,5x26 h.



ST09 0065

### 1 - CESTINO GETTACARTA ACCIAIO LUCIDO AISI 304 65 LT

Cestino gettacarta senza coperchio in acciaio inox lucido, capacità lt. 65. Installabile a parete con viti o semplicemente in appoggio al pavimento. Ingombro cm. 31x22x60 h.

ST09 9065

### 2 - COPERCHIO ACCIAIO LUCIDO AISI 304

Per cestino gettacarta lt. 65. Ingombro cm. 31x22x2 h.



R001 2309

#### DISPENSER MINI ACCIAIO SATINATO

Distributore in acciaio inox satinato per carta igienica intercalata a salvietta.  
Ingombro cm. 13,5x11,5x13,5 h.



ST01 1300

#### LONDON P.A.C. ACCIAIO LUCIDO

Distributore per salviette asciugamano. Realizzato in acciaio inox lucido. Ingombro cm. 26,5x12x38 h, capacità 450 salviette circa.



ST01 3770

#### PASTAFILL LOTION ACCIAIO LUCIDO

Distributore di sapone liquido con ricarica a rabbocco contenuto ml. 1500. Realizzato in acciaio inox lucido. Ingombro cm. 12,5x12x30 h.



ST01 2620

#### LONDON MINI ACCIAIO LUCIDO

Distributore in acciaio inox lucido per carta igienica jumbo MINI. Ingombro cm. 23x12x23 h.



ST01 2600

#### LONDON MAXI ACCIAIO LUCIDO

Distributore carta igienica jumbo in acciaio inox lucido. Ingombro cm. 31x12x31 h.



HQ01 4105

**NEAT AIR PRO 1 "FC"  
ACCIAIO CROMATO**

Asciugamano ad aria calda in acciaio cromato. Funzionamento a fotocellula. Omologato IMQ e TUV. Ingombro cm. 27x20x24 h.



HQ01 4100

**NEAT AIR PRO 2 "FB"  
ACCIAIO PORCELLANATO BIANCO**

Asciugamano ad aria calda in acciaio porcellanato. Funzionamento fotocellula. Omologato IMQ e TUV. Ingombro cm. 27x20x24 h.



J001 4120

**STANDARD F**

Asciugamano elettrico ad aria calda in ABS antiurto. Funzionamento a fotocellula. Omologato IMQ. Potenza motore 100 watt, resistenza 2000 watt. Ingombro cm. 22,5x16x30 h.



J001 4020

**STANDARD P**

Asciugamano elettrico ad aria calda in ABS antiurto. Funzionamento a pulsante. Omologato IMQ. Potenza motore 100 watt, resistenza 2000 watt. Ingombro cm. 22,5x16x30 h.



PR01 4100

### CX 1000 ASCIUGAMANO BIANCO

Asciugamani bianco ad alta efficacia, asciuga le mani in 18 secondi. Più efficacia consumando meno energia. Affissione schermo LCD. Tensione 220v, consumo 850w. Resistenza all'acqua: IPX1. Volume di ventilazione 150mc/ora, velocità di ventilazione 68 m/s, livello sonoro 80 dba. Dimensioni cm. 29,5x25x65 h. Peso kg. 15,5.



PR01 4105

### CX 1000 ASCIUGAMANO SATIN

Asciugamani grigio satinato ad alta efficacia, asciuga le mani in 18 secondi. Più efficacia consumando meno energia. Affissione schermo LCD. Tensione 220v, consumo 850w. Resistenza all'acqua: IPX1. Volume di ventilazione 150mc/ora, velocità di ventilazione 68 m/s, livello sonoro 80 dba. Dimensioni cm. 29,5x25x65 h. Peso kg. 15,5.



JV01 4100

### AIRWAVE BIANCO ASCIUGAMANO AD ARIA CALDA

Apparecchio asciugamani ad aria calda in plastica rinforzata bianca funzionamento a fotocellula con timer. Tempo di asciugatura dai 10 ai 15 secondi. Potenza motore 1400 watt. Resistenza riscaldamento 800 watt. La superficie è di facile pulizia e manutenzione. Ingombro cm. 25x16x47 h.





J001 4320

### CAPRICO NEAT & NEAT

Asciugacapelli ad aria calda in ABS antiurto. Funzionamento anche come asciugamano con fotocellula. Ingombro cm. 22,5x12,2x17 h.



HQ01 4440

### ASCIUGACAPELLI PRO 3

Asciugacapelli ad aria calda in ABS antiurto. 2 velocità con accensione e spegnimento automatico (appena si lascia la presa) marchio CE. Potenza e riscaldamento minima 500 watt, max 1200 watt. Ingombro cm. 10x18x20 h.



VA01 4446

### ATHELIER SHAWE ASCIUGACAPELLI HOTEL CON TUBO

Apparecchio asciugacapelli con tubo flessibile automatico da 100 watt di potenza motore e 900 watt di riscaldamento, totale 1000 watt. Ingombro cm. 19x12,5x30 h.





ST01 2505

### LONDON MAXI T

Distributore carta igienica jumbo.  
Ingombro cm. 37,5x13,5x36 h.



ST01 2525

### LONDON MINI T

Distributore carta igienica mini jumbo.  
Ingombro cm. 27x12x25,2 h.



ST01 2500

### LONDON MAXI B

Distributore carta igienica jumbo.  
Ingombro cm. 37,5x13,5x36 h.



ST01 2520

### LONDON MINI B

Distributore carta igienica mini jumbo.  
Ingombro cm. 27x12x25,2 h.



LR03 5140

### ROTOLO CARTA IGIENICA JUMBO 1400

Carta igienica rotolo jumbo in cellulosa doppio velo in confezione da 6 maxirotoli da kg. 1,400/390 mtl. ca. cadauno.



LR03 5120

### ROTOLO CARTA IGIENICA JUMBO 1200

Carta igienica rotolo jumbo in cellulosa doppio velo in confezioni da 6 maxirotoli da kg. 1,200/350 mtl. ca. cadauno.



LR03 5110

### ROTOLO CARTA IGIENICA JUMBO 1000

Carta igienica a rotoli jumbo in cellulosa doppio velo in confezioni da 6 maxirotoli da kg. 1,000/295 mtl. ca. cadauno.



LR03 7120

### ROTOLO CARTA IG. JUMBO 500 MAXI

Carta igienica a rotoli jumbo in ovatta nazionale 2 veli goffrata in confezioni da 6 maxirotoli da kg. 1,200/320 mtl. ca. cadauno.



LR03 7100

### ROTOLO CARTA IG. JUMBO 500 MEDI

Carta igienica a rotoli jumbo in ovatta nazionale 2 veli goffrata in confezione da 6 rotoli medi da kg. 1,000/280 mtl. ca. cadauno.



LR03 8120

**ROTOLO CARTA IGIENICA  
JUMBO OVATTINA 1200**

Carta igienica a rotoli jumbo in ovattina doppio velo in confezione da 6 maxi rotoli da kg. 1,200/300 mtl. ca. cadauno.



LR03 5072

**ROTOLO CARTA IGIENICA  
JUMBO MINI CELLULOSA**

Carta igienica a rotoli minijumbo in pura cellulosa 2 veli gofrata in confezione da 12 rotoli da gr. 630/200 mtl. cadauno con pretaglio.



LR03 7072

**ROTOLO CARTA IGIENICA  
JUMBO MINI 500**

Carta igienica in rotoli minijumbo in ovatta nazionale 2 veli in confezioni da 12 rotoli da gr. 630/190 mtl. cadauno con pretaglio.



LR03 8072

**ROTOLO CARTA IGIENICA  
JUMBO MINI OVATTINA**

Carta igienica a rotoli minijumbo in ovattina 2 veli in confezioni da 12 rotoli da gr. 630/180 mtl. cadauno con pretaglio.





ST01 2205

### DISPENSER MAXI T

Distributore carta igienica intercalata in foglietti in ABS antiurto trasparente.  
Ingombro cm. 14x11,3x32 h.



ST01 2225

### DISPENSER MINI T

Distributore carta igienica intercalata in foglietti in ABS antiurto trasparente.  
Ingombro cm. 14x11,3x17 h.



ST01 2200

### DISPENSER MAXI B

Distributore carta igienica intercalata in foglietti in ABS antiurto bianco.  
Ingombro cm. 14x11,3x32 h.



ST01 2220

### DISPENSER MINI B

Distributore carta igienica intercalata in foglietti in ABS antiurto bianco.  
Ingombro cm. 14x11,3x17 h.



CE03 5330

#### NEAT PACK 3V

Carta igienica a salvietta interfogliata in pura cellulosa 3 veli incollati cm. 11x27. Confezione da 36 fasce per 110 pezzi totale 3960 salviette.



CE03 5320

#### IGIENICA INTERCALATA NEAT PACK 2V

Carta igienica intercalata 2 veli pura cellulosa microincollata. Foglietti cm. 11x18,5. 36 fasciette da 250 pezzi, totale 9000 salviette. Per DISPENSER.



CE03 5322

#### EURO FOLD

Carta igienica fascettata a salvietta intercalata, cm. 12,5x21, 2 veli in pura cellulosa microincollata bianca (cartone da 30 pacchi da 260 salviette, totale 7800 pezzi).

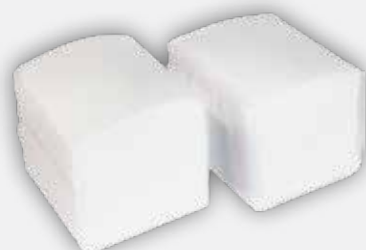

PA03 5327

#### IGIEN FOLD

Carta igienica fascettata a salvietta intercalata, cm. 12,5x21, 2 veli in pura cellulosa bianca (cartone da 40 pacchi da 250 salviette, totale 10.000 pezzi).



CE03 5340

#### CARTA COLORATA NEAT PACK ROSA

Carta igienica a salvietta interfogliata in pura cellulosa 2 veli incollati cm. 11x18,5. Confezione da 36 fasce per 250 pezzi totale 9000 salviette.



CE03 5350

#### CARTA COLORATA NEAT PACK LILLA

Carta igienica a salvietta interfogliata in pura cellulosa 2 veli incollati cm. 11x18,5. Confezione da 36 fasce per 250 pezzi totale 9000 salviette.



ST01 2015

#### VISIOLET

Distributore carta igienica in rotolino (autonomia 2 rotoli) in ABS antiurto.  
Ingombro cm. 15,8x17,6x25,1 h.



TA01 2020

#### FORMAT

Distributore carta igienica in rotolino in PVC antiurto. Ingombro cm. 16x13x13 h.



QT01 2030

#### VERTICAL 2 DISPENSER

Distributore in abs antiurto per carta igienica a rotolino. Contiene fino a due rotoli. Dotato di ferrovia verticale per utilizzo di carta con animelle in plastica. Finito il primo rotolo scende automaticamente il secondo. Utilizzare carta DUAL ROLL. Ingombro cm. 18x16x32 h.



CE03 5030

#### DUAL ROLL

Carta igienica in rotolino con animella laterale in pura cellulosa compatta 2v. Contiene 500 strappi da cm. 10x20. Totale 100 mfl. Cartone da 36 rotolini. Da utilizzare su VERTICAL 2.



LR03 5010

**BELLA**

Carta igienica in rotolino 2 veli pura cellulosa bianca gr. 100. Confezioni da 96 rotoli (16 pacchi da 6 rotoli).

LR03 5007

**BELLA C**

Carta igienica in rotolino di pura cellulosa 2 veli da gr. 70. Confezione da 120 rotoli (20 pacchi da 6 rotoli).



LR03 7010

**NUVOLA**

Carta igienica in rotolino 2 veli ovatta nazionale bianca gr. 100. Confezioni da 96 rotoli (16 pacchi da 6 rotoli).

LR03 7007

**NUVOLA C**

Carta igienica in rotolino 2 veli ovatta nazionale bianca gr. 70. Confezione da 120 rotoli (20 pacchi da 6 rotoli).



WC03 5020

**IGIENICA 200 STRAPPI**

Carta igienica in rotolino di pura cellulosa 2 veli microcollati da 200 strappi cadauno. Confezione da 120 rotoli (12 pacchi da 10 rotoli).



NR03 5010

### GRAZIOSA PROFESSIONAL

Carta igienica profumata in rotolo, pura cellulosa 2 veli microcollati, 190 strappi cad. Confezione da 120 rotoli (12 pacchi da 10 rotoli).



CE03 5013

### IGIENICA 3V PAPER FLOWERS

Carta igienica in rotolino di pura cellulosa 3 veli incollati punta-a-punta. Rotolo da 250 strappi 170 grammi. Confezione da 72 rotoli (9 pacchi da 8 rotoli).



LR03 5020

### OBELIX

Carta igienica compatta in rotolino 2 veli, in pura cellulosa bianca, 500 strappi. Confezione da 40 rotoli (10 pacchi da 4 rotoli).



NR03 5107

### SOFT ROLL

Carta igienica fascettata in rotolino 2 veli incollati di pura cellulosa bianca profumata. Confezione da 96 rotoli (24 pacchi da 4 rotoli) 200 strappi cadauno.



NR03 5109

### IGIEN ROLL SCUDETTO

Carta igienica fascettata in rotolino 2 veli incollati di pura cellulosa bianca profumata, 180 strappi cad. Confezione da 96 rotoli (24 pacchi da 4 rotoli).



AL01 6505

### 1 - DISTRIBUTORE COPRI WC T

Distributore manuale carta copri wc in ABS trasparente. Ingombro cm. 21x5,8x27,5 h.

AL01 6500

### 2 - DISTRIBUTORE COPRI WC B

Distributore manuale carta copri wc in ABS bianco. Ingombro cm. 21x5,8x27,5 h.



SP08 3460

### CARTA COPRI WC

Ricarica carta copri wc manuale (ricarica da 200 pezzi in confezioni da 10).



WA01 6600

### DISTRIBUTORE COPRI WC AUTOMATICO

Distributore copri wc automatico in metallo smaltato con leva di estrazione. Ingombro cm. 39x3,5x30,5 h.



WA08 3400

### CARTA COPRI WC

Ricarica carta copri wc automatico (ricarica da 100 pezzi in confezioni da 12).



AL01 6305

### 1 - PORTA SACCHETTI IGIENICI T

Distributore manuale porta sacchetti igienici in ABS trasparente. Ingombro cm. 13,8x4,5x29 h.

AL01 6300

### 2 - PORTA SACCHETTI IGIENICI B

Distributore manuale porta sacchetti igienici in ABS bianco. Ingombro cm. 13,8x4,5x29 h.



NI08 3510

### SACCHETTINI IGIENICI POLITENATI

Ricarica sacchettini igienici politenati (confezione da 1000 sacchetti).



PA08 3510

### SMALL IGIEN BAG

Ricarica sacchettini igienici in politere (ricarica da 25 sacchetti confezione da 48 scatole).



PA01 6315

### 1 - IGIEN BAG CROMATO

Distributore manuale porta sacchetti igienici in ABS cromato. Ingombro cm. 9,6x3,9x13,7 h.

PA01 6310

### 2 - IGIEN BAG BIANCO

Distributore manuale porta sacchetti igienici in ABS bianco. Ingombro cm. 9,6x3,9x13,7 h.



AL01 6100

**DISTRIBUTORE PORTAVELINE B**

Distributore manuale porta veline strucco in ABS bianco. Ingombro cm. 26x5,5x13,5 h.



ST01 6115

**DISTRIBUTORE PORTA VELINE CROMATO**

Distributore manuale porta veline cromato. Ingombro cm. 26x13,5x5,5 h.



CE08 3100

**VELINE COSMETICHE**

Ricarica veline cosmetiche in pura cellulosa 2 veli morbidissima (ricarica da 100 veline confezione da 40 scatole).

**PITTOGRAMMI PER TOILETTE**

Placche in alluminio con serigrafia grigio scuro muniti di biadesivo per fissaggio. Ingombro cm.14,2x12,2.

R035 9906



R035 9901



R035 9902



R035 9822



R035 9904



R0359907







MC01 6850

### CIAMBELLA MASTERPIECE

Ciambella copri wc autoigienizzante con sollevamento automatico.



IN11 0072

H.A.C.C.P.

### AF200 TOILETTE DISINFETTANTE

Igienizzante alcoolico per ciambella masterpiece o per Mini Modular Spray Dispenser WC in flaconi da litri 2 (cartone da 4 flaconi).



VE08 3470

### STRISCIA SIGILLO WC "DISINFETTATO"

Sigillo in carta per wc camere hotel cm. 50x6 (confezione da 5000 sigilli).



CP01 6850

### CIAMBELLA SANISIT

Apparecchi semplice e funzionale che, tramite un azionamento pratico e sicuro, posiziona una pellicola monouso tra te e l'asse del water. Soluzione ideale per tutte le attività con servizi igienici a disposizione della clientela.



CP08 3420

### PELLICOLA IGIENICA IN ROTOLO

Pellicola igienica in rotolo per Sanisit. Ogni rotolo ha una lunghezza pari ad 80 azionamenti. Confezione da 50 rotoli.

42

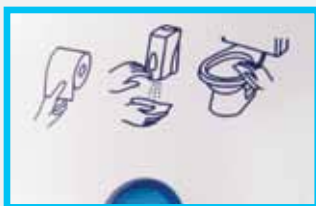

AM01 3003

### MINI MODULAR SPRAY DISPENSER WC A RIEMPIMENTO

Distributore in abs bianco e azzurro con contenitore da lt.0,4 per detergente SPRAY DISINFETTANTE per ciambella WC. Ingombro cm 9x9,8x19 h.

AM01 3005

### MINI MODULAR SPRAY WC S CON SACCA

Distributore in abs bianco e azzurro per detergente SPRAY DISINFETTANTE per ciambella WC. Da utilizzare con sacca. Ingombro cm 9x9,8x19 h.



SM11 0073

H.A.C.C.P.

### AF 200 IGENIZZANTE ML. 400 IN SACCA

Igienizzante alcolico per Mini Modular Spray Dispenser Wc S in sacca da ml. 400. Cartone da 10 sacche.



J001 6402

### BABY CHANGER FASCIATOIO

Fasciatoio basculante HDPE bianco per neonato senza accessori.

Ingombro da aperto cm. 87x45,7x40,6 h, da chiuso cm. 87x9,7x45,7 h.



VC01 6406

### BABY SEAT WHITE

Seggiolino in LPDE per bambini con cinture di sicurezza. Portata kg. 90.

Ingombro cm. 33,4x10,2x52,7 h.

Aperto sporge di cm. 29,7.



43



EL35 2555

### 1 - SPECCHIO RETTANGOLARE FISSO

Specchio rettangolare con telaio in ABS con bordo in plastica bianca. Ingombro cm. 48x58.

EL35 2558

### 2 - MENSOLA PLASTICA

Per specchio rettangolare.



R035 2550

### SPECCHIO OVALE BASCULANTE

Specchio ovale basculante con telaio in acciaio cromato. Ingombro cm. 51x59.5 e distanza da parete cm. 7.



JV35 6303

### SPECCHIO HOTEL ROTONDO DA PARETE

Specchio hotel rotondo bifacciale da parete con braccio estensibile e finiture cromate. Visione normale e nel secondo lato visione moltiplicata per 3 volte. Diametro dello specchio cm. 20. Ingombro a parete cm. 24,5x31 h. Braccio estensibile allungabile fino cm. 30,5 da parete.

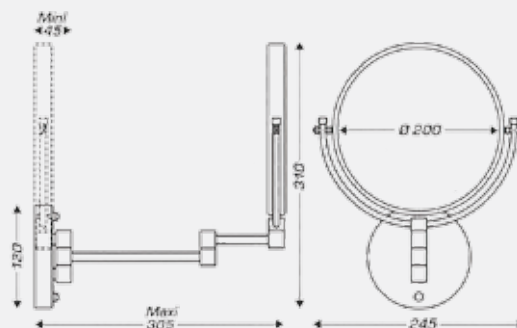

MA35 2682

### APPENDIABITI BAGNO TW INOX

Appendi abiti in ottone cromato diametro cm. 4,5 e profondità cm. 4.





ME09 0410

### CONTENITORE ASSORBENTI USATI

Contenitore assorbenti usati realizzato in acciaio inox con sportello a scomparsa.  
Ingombro cm. 30x20x71 h.



FI09 0117

### DESY LT 17

Contenitore in ABS porta assorbenti igienici usati con pedale alza coperchio (a bocca di lupo a scomparsa). Ingombro cm. 54x20x42 h.



VW11 0088

### PARAFORMALDEIDE 1G

Pasticca disinfettante solida da gr. 1 utilizzabile nelle pattumiere o nei cesti ove si voglia controllare la proliferazione batterica. Confezione da 6 barattoli da 800 pasticche cad.

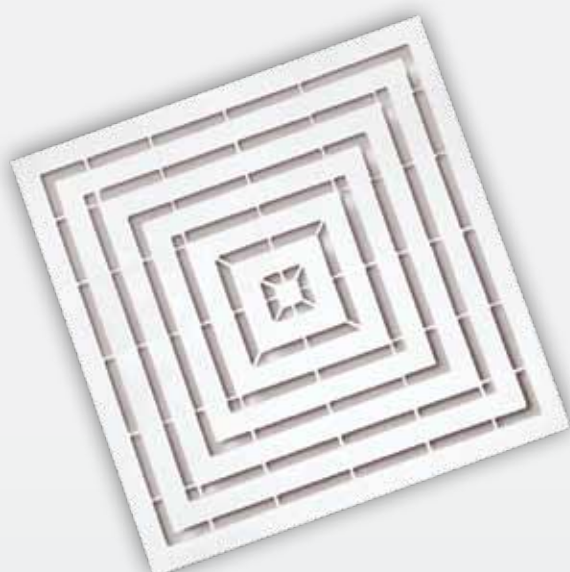

GI04 4325

### PEDANA DOCCIA IN PVC

Pedana in PVC per doccia cm. 50x50x2,5 h.



R008 1153

### PORTASCOPINO "INOX"

Portascopino inox cromo. Ingombro cm. 9x37,1 h.

R008 5108

### PORTASCOPINO MURALE INOX

Portascopino con fissaggio a muro in metallo cromato. Ingombro cm. 9x37,1 h.



R008 1800

### PORTASCOPINO MURALE INOX 430

Porta scopino murale in acciaio inox. Bacinella di recupero in PVC. Ingombro cm. 10x38 h.



MA08 0658

### PORTASCOPINO SATIN DA PARETE

Portascopino a muro in plastica satinata. Ingombro cm. 12x12x51,5 h.



LP08 0688

### PORTASCOPINO MURALE GIRONET

Portascopino murale in plastica bianca (aperto/chiuso). Ingombro cm. 11,5x12,5x39 h.





MA08 0654

### PORTASCOPINO SATIN A TERRA

Portascopino a terra in plastica satinata.  
Ingombro cm. 15x7,2x45 h.



R008 1143

### PORTASCOPINO

Portascopino in metallo verniciato bianco.  
Ingombro cm. 9x37,1 h.



GS08 1699

### PORTASCOPINO WC GIO

Portascopino wc chiuso in ABS.  
Ingombro cm. 11,5x11,5x41 h.



LP08 0699

### PORTASCOPINO ELITE

Portascopino wc aperto in ABS.  
Ingombro cm. 18x21 h.



LP08 0696

### SCOPINO SINGOLO PER PORTASCOPINO ELITE

Scopino WC singolo senza porta scopino.



ST01 3505

### LONDON 1000 C T

Dosatore di sapone trasparente con ricarica a cartuccia in ABS antiurto.  
Ingombro cm. 12x10x25 h.



ST01 3515

### LONDON 500 C T

Dosatore di sapone trasparente con ricarica a cartuccia in ABS antiurto.  
Ingombro cm. 12x10x18,5 h.



ST01 3500

### LONDON 1000 C B

Dosatore di sapone bianco con ricarica a cartuccia in ABS antiurto.  
Ingombro cm. 12x10x25 h.



ST01 3510

### LONDON 500 C B

Dosatore di sapone bianco con ricarica a cartuccia in ABS antiurto.  
Ingombro cm. 12x10x18,5 h.





1



3



5



7



8



9



10



2



4



6

EC04 1081

1 - **CREMANI FORTE 333**

Detergente liquido ph neutro in crema per sporco pesante profumato. Contenuto ml. 700. Ricarica per LONDON 1000 C (confezione da 12 flaconi).

EC04 1061

2 - **CREMANI 400**

Detergente liquido in crema ph neutro profumato. Contenuto ml. 700. Ricarica per LONDON 1000 C (confezione da 12 flaconi).

EC04 1066

3 - **CREMANI 450**

Detergente liquido in crema ph neutro profumato. Contenuto ml. 700. Ricarica per LONDON 1000 C (confezione da 12 flaconi).

EC04 1068

4 - **CREMANI 450  
NON PROFUMATO**

Detergente liquido ph neutro in crema non profumato. Contenuto ml. 700. Ricarica per LONDON 1000 C (confezione da 12 flaconi).

EC04 1071

5 - **CREMANI BODY 500**

Detergente liquido ph neutro in crema profumato. Contenuto ml. 700. Ricarica per LONDON 1000 C (confezione da 12 flaconi).

EC04 1076

6 - **CREMANI 550**

Detergente liquido in crema ph 5.5 profumato. Contenuto ml. 700. Ricarica per LONDON 1000 C (confezione da 12 flaconi).

EC04 1091

7 - **CREMANI 888**



Detergente liquido in crema ph neutro disinfettante non profumato. Contenuto ml. 700. Ricarica per LONDON 1000 C (confezione da 12 flaconi).

EC04 2062

8 - **CREMANI 400**

Detergente liquido in crema ph neutro profumato. Contenuto ml. 350. Ricarica per london 500 C (confezione da 20 flaconi).

EC04 2067

9 - **CREMANI 450**

Detergente liquido in crema ph neutro profumato. Contenuto ml. 350. Ricarica per london 500 C (confezione da 20 flaconi).

EC04 2077

10 - **CREMANI 550**

Detergente liquido in crema ph 5.5 profumato. Contenuto ml. 350. Ricarica per london 500 C (confezione da 20 flaconi).



ST01 3812

### LONDON 800 BAG IN BOX

Dosatore di sapone bianco con ricarica a bag in box in ABS antiurto.  
Ingombro cm. 12x10x25 h.

ST01 3800

### AUTOMATIC DISPENSER

Dosatore di sapone bianco elettronico a fotocellula con ricarica a bag in box in ABS antiurto, alimentazione a batteria.  
Ingombro cm. 13,5x10x25,5 h.

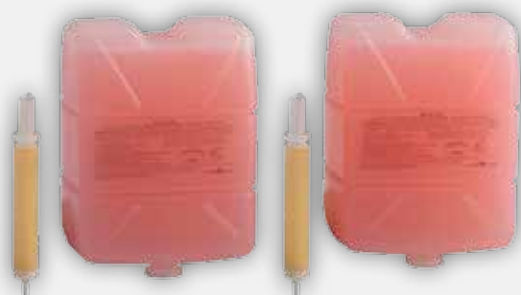

ST04 1001

### SICC PINK DELUXE

Sapone liquido rosa in sacca bag in box da ml. 800. Ph 7,5. Leggermente profumato delicato.  
Cartone da 12 sacche.

ST04 1002



### ISTANT SKIN DISINFETTANTE ALCOOL GEL

Sapone in lozione battericida a base di alcol etilico pronta all'uso, da utilizzare su mani pulite e tra due lavaggi. Non necessita né di acqua, né di asciugamano perché evapora rapidamente.  
Sacca bag in box da ml. 800. Ph 7,5. Cartone da 12 sacche.



SA01 3700

### ELBOW DISPENSER SAPONE A LEVA/GOMITO

Distributore in ABS grigio e bianco con contenitore da lt.1 a rabbocco per sapone detergente. Funzionamento a leva in acciaio azionabile anche con il gomito.  
Ingombro cm. 10,5x9x28,5 h.  
La profondità dove c'è la leva d'acciaio a gomito da cm. 9 passa a cm. 22.



BF01 3000

H.A.C.C.P.

### COLONNA MOBILE

Colonna mobile in metallo verniciato per dispenser in abs automatico che eroga igienizzante. Adatta per industrie alimentari, laboratori, pasticcerie etc. Ingombro base  $\varnothing$  cm. 40 x altezza cm. 140.



GA01 6800

### STERIHANDS

Erogatore nebulizzatore per sapone disinfettante a base alcolica. Ingombro cm. 27x22x40,5 h. Funzionamento a batteria o a corrente.



GA11 0068

H.A.C.C.P.

### ESO FORM

Disinfettante da utilizzare con erogatore nebulizzatore STERIHANDS. Non occorre risciacquo. Flacone da 1 lt. Presidio medico chirurgico Reg. num. 16354 del Min. della Salute. Cartone da 12 flaconi.



ST01 3610

### VISIOSOAP FOAM

Dosatore bianco di sapone a schiuma, funzionamento a ricarica in cartucce. Realizzato in ABS antiurto, ingombro cm. 6,5x10,5x27 h.



ST04 3041

### NEAT FOAM

Sapone schiuma per distributore VISIOSAOP FOAM. Flacone da ml. 500. Ph 7.  
Cartone da 12 flaconi.



ST01 3811

### LONDON 800 R

Dosatore di sapone bianco con ricarica a rabbocco in ABS antiurto. Contenuto ml. 800.  
Ingombro cm. 12x10x25 h.



ST01 3120

### LONDON 500 R

Dosatore di sapone bianco con ricarica a rabbocco in ABS antiurto. Contenuto ml. 500.  
Ingombro cm. 12x10x18,5 h.



ST01 3235

### AM 800 R

Dosatore di sapone trasparente con ricarica a rabbocco in ABS antiurto. Contenuto ml. 800.  
Ingombro cm. 12,3x10x20,3 h.



ST01 3215

### SAM 600 R

Dosatore di sapone trasparente con ricarica a rabbocco in ABS antiurto. Contenuto ml. 600. Ingombro cm. 7,8x10x21 h.



EC04 0560

### CREMANI 400

Detergente liquido in crema ph neutro profumato. Ph 7. Contenuto kg. 5 (confezione da 4 taniche).



EC04 0565

### CREMANI 450

Detergente liquido in crema ph neutro profumato. Ph 7. Contenuto kg. 5 (confezione da 4 taniche).



EC04 0571

### CREMANI BODY 500

Detergente liquido in crema ph neutro colore rosa con profumo tipo DOVE. Ph 7. Tanica da ml. 5000 (confezione da 4 taniche).



EC04 0575

### CREMANI 550

Detergente liquido in crema ph 5.5 profumato. Ph 5,5. Contenuto kg. 5 (confezione da 4 taniche).



EC04 0590



### CREMANI 888

Detergente liquido in crema con disinfettante ph neutro non profumato. Ph 7. Contenuto kg. 5 (confezione da 4 taniche).



# LINEA HOTEL



MA04 9865

**SHOWERGEL SHAMPOO DOCCIA  
GIALLO ML. 300**

Doccia shampoo in flacone erogatore da gr. 300 per mani e corpo.  
Ph 5. Scatole da 12 flaconi.

MA04 9965

**CREAM SOAP DETERGENTE PER MANI E  
CORPO BIANCO ML. 300**

Sapone in flacone erogatore da gr. 300 per mani e corpo.  
Ph 5,5. Scatole da 12 flaconi.



MA01 0665

**CHARM SUPPORTO CON CHIAVE PER  
FLACONE ML. 300**

Supporto in ABS bianco per cartuccia di sapone con erogatore.



MA01 0651

**DISPENSER A RABBOCCO PER SAPONE  
LIQUIDO CON PIASTRA**

Distributore di sapone a riempimento in ABS bianco e trasparente da ml. 170.  
Ingombro cm. 6x8x17 h.



MA01 1583

**DISPENSER A RABBOCCO PER SAPONE  
LIQUIDO CROMATO/TRASPARENTE**

Distributore di sapone a riempimento in ABS cromato e trasparente da ml. 170.  
Ingombro cm. 5,5x7,5x15 h.



MA01 0764

### KALLA DISPENSER BIANCO/TRASPARENTE A RIEMPIMENTO

Distributore di sapone a riempimento in abs bianco e trasparente. Contiene fino a ml. 170. Ingombro cm. 7,5x5,5x15 h.



MA01 2764

### KALLA GLASS DISPENSER SATINATO A RIEMPIMENTO

Distributore di sapone a riempimento in abs satinato e trasparente. Contiene fino a ml. 170. Ingombro cm. 7,5x5,5x15 h.



MA01 1764

### KALLA GLASS DISPENSER CROMATO A RIEMPIMENTO

Distributore di sapone a riempimento in ABS cromato e trasparente. Contiene fino a ml. 170. Ingombro cm. 7,5x5,5x15 h.

56

MA04 9906

### DETERGENTE MANI DAYFRESH VERDE ML. 200

Ricarica detergente liquido per mani ph 5,5, colore verde in flacone ricarica da ml. 200. Cartone da 72 flaconi.



MA04 9806

### SHAMPOO DOCCIA SHOWERFRESH GIALLO ML. 200

Ricarica Shampoo doccia ph 5,0, colore giallo in flacone ricarica da ml. 200. Cartone da 72 flaconi.



MA01 0606

### DISPENSER BIANCO/TRASPARENTE PER SHAMPOO/MANI ML. 200

Distributore di sapone a ricarica in ABS bianco e trasparente. Da utilizzare con ricariche da ml. 200. Ingombro cm. 5,5x7,5x18 h.





ST01 3536

### SM HOTEL ABS CROMATO

Dosatore in polipropilene antiurto cromato per sapone e shampoo doccia con ricarica a cartuccia. Contenuto cartuccia da ml. 200. Ingombro cm. 5,5x6,9x17,9 h.



ST01 3534

### SM HOTEL ABS ARANCIO

Dosatore in ABS per sapone e shampoo doccia con ricarica a cartuccia. Contenuto cartuccia da ml. 200. Ingombro cm. 5,5x6,9x17,9 h.



ST01 3530

### SM HOTEL ABS BIANCO

Dosatore in ABS per sapone e shampoo doccia con ricarica a cartuccia. Contenuto cartuccia da ml. 200. Ingombro cm. 5,5x6,9x17,9 h.



ST04 1100

### BODY SHAMPOO SM HOTEL

Detergente liquido in crema e bagno doccia ph neutro profumato. Ph 7. Contenuto ml. 200. Ricarica per SM HOTEL (confezione da 12 flaconi).



ST01 3010

### VASCHETTA A RIEMPIMENTO PER SM HOTEL

Ricarica a rabbocco ml. 200.



GF01 3330

**STAFFA SQUEEZE PORTA DISPENSER  
BIANCA LUCIDA**

Portaricarica in plastica bianca lucida.  
Disponibile per montaggio a vito o biadesivo.  
Confezione da 20 staffe.



GF04 1330

**RICARICA SQUEEZE SHAMPOO DOCCIA  
COLOR CHAMPAGNE**

Shampoo doccia ad azione nutriente ai fiori di tiglio con estratti di ginkgo biloba in flacone ricarica da ml 330. Ph 5,5-6.  
Confezione da 24 ricariche.



GF04 1331

**RICARICA SQUEEZE DETERGENTE MANI  
COLORE BIANCO**

Emulsione detergente per mani ad azione vellutante e protettiva in flacone ricarica da ml. 330. Ph 7. Confezione da 24 ricariche.



IN04 4532

H.A.C.C.P.

### SUPER CARE ANTIBATTERICO

Detergente liquido in crema ph neutro antibatterico. Ph 6. Contenuto ml. 500 (confezione da 12 flaconi).

IN04 4522



### SUPER CARE NEUTRO DELICATO

Detergente liquido in crema ph neutro delicato. Ph 6. Contenuto ml. 500 (confezione da 12 flaconi).

IN04 4540

H.A.C.C.P.

### OXALIS ALCOOL GEL LAVAMANI

Detergente liquido in crema ph neutro lavamani igienizzante, non occorre risciacquo. Ph 6. Contenuto ml. 500 (confezione da 12 flaconi).



IN04 4512



### SUPER CARE DERMOLIQUIDO

Detergente liquido in crema ph neutro delicato, bagno doccia. Ph 5. Contenuto ml. 500 (confezione da 12 flaconi).



IN04 9002

### SUPER CARE SHAMPOO NEUTRO

Detergente liquido in crema ph neutro delicato shampoo. Ph 5. Contenuto ml. 1000 (confezione da 12 flaconi).



IN04 7012

### SUPER BAGNO DOCCIA LATTE

Detergente liquido in crema ph neutro bagno doccia latte. Ph 5. Contenuto ml. 1000 (confezione da 12 flaconi).

POSSIBILITÀ PERSONALIZZAZIONE



### SHAMPOO BAGNO DOCCIA IN FLACONCINO PERSONALIZZATO



IT04 4100

### BEAUTY CREAM SOAP

Saponetta da gr. 125 incartata singolarmente (cartone da 24 stecche da 3 pezzi cadauna, totale 72 pezzi).



JV35 6375

### ZENITH TEIERA ELETTRICA BIANCA LT. 0,8

Teiera elettrica con struttura abs da ml. 800 completa di base di riscaldamento e led luminoso di funzionamento. Potenza nominale 1100 watt può ruotare sulla propria base a 360°. Ingombro cm. 20x12,5x19 h.

JV35 6380

### 1 - ZEN LINE VASSOIO PRINCIPALE BIANCO

Vassoio principale per servizio da the/infusi in plastica bianco antimacchia con apposito sistema di appoggio della teiera. Possibilità di agganciare lateralmente anche il vassoio di servizio infusi. Ingombro cm. 37,7x27,8x2,5 h.

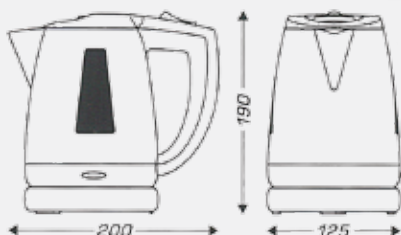

JV35 6382

### 2 - ZEN LINE VASSOIO SERVIZIO INFUSI BIANCO

Vassoio servizio infusi bianco in plastica antimacchia dotato di sistema di aggancio al vassoio principale. Ingombro cm 32,7x13,3x1 h.



JV35 6384

### 3 - ZEN LINE PORTAINFUSI PICCOLO BIANCO

Portainfusi piccolo bianco in plastica antimacchia. Ingombro cm 15,2x11,5x4,9 h.

JV35 6383

### 4 - ZEN LINE PORTAINFUSI GRANDE BIANCO

Portainfusi grande bianco in plastica antimacchia. Ingombro cm. 21,5x11,4x4,9 h.

# LINEA CORTESIA GOLD



GF25 9515

**SET MINICUCITO IN  
ASTUCCIO DI CARTONE**

GF08 2050

**CUFFIA DOCCIA IN BUSTA**

GF04 6025

**SAPONETTA GR. 20 IN  
ASTUCCIO DI CARTONCINO**

GF08 2045

**CUFFIA DOCCIA  
IN ASTUCCIO DI  
CARTONCINO**



GF25 9906

**VASSOIO PLEXIGLAS  
BIANCO SATINATO**

GF25 9505

**SPUGNA LUSTRA  
SCARPE IN ASTUCCIO  
DI CARTONCINO**

Vassoio in plexiglass bianco satinato cm.  
21,8x14,5x1,5 per prodotti linea cortesia.

GF04 6538

**SHAMPOO-DOCCIA IN  
FLACONCINO ML. 38**

GF04 6505

**BAGNO DOCCIA  
SHAMPOO ML. 10**

GF04 6005

**SAPONETTINA PER  
ALBERGO DA GR. 14  
INCARTATA SINGOLARMENTE**

Bustine monodose doccia shampoo da ml. 10  
(confezioni da 600 bustine).

Saponettina profumata monouso gr. 14  
(confezioni da 500 saponettine).



## LINEA CORTESIA TRAVEL CARE



GF25 9514

SET MINICUCITO IN  
ASTUCCIO DI CARTONE

GF25 9554

SET 4 COTTON FIOC + 3  
BATUFFOLI DI COTONE IN  
ASTUCCIO DI CARTONE

GF04 6534

SHAMPOO-DOCCIA IN  
FLACONCINO ML. 30

GF04 6502

BAGNO DOCCIA SHAMPOO  
ML. 10 IN BUSTINA  
POLIESTERE MONODOSE

GF08 2040

CUFFIA DOCCIA  
IN BUSTINA

GF08 2044

CUFFIA DOCCIA IN  
ASTUCCIO DI CARTONCINO

GF04 6000

SAPONETTINA  
INCARTATA GR. 14

GF25 9702

SPAZZOLINO CON  
COPRISETOLE E DENTIFRICIO  
IN BUSTA SIGILLATA SINGOLA

GF25 9602

SET BARBA: RASOIO BILAMA  
CON GEL DA BARBA

GF25 9502

SALVIETTA TNT  
LUSTRASCARPE

GF21 9070

SACCHETTO HOTEL PER  
BIANCHERIA CM. 40X60

GF25 9904

ESPOSITORE PLEXIGLASS  
BIANCO SATINATO



Espositore in plexiglass bianco satinato  
cm. 20x7x9 h, per prodotti linea cortesia.



## LINEA CORTESIA PRIJA



GF08 2042

CUFFIA DOCCIA IN ASTUCCIO  
DI CARTONCINO

GF25 9506

SPUGNA LUSTRA SCARPE IN ASTUCCIO  
DI CARTONCINO

GF04 6544

SHAMPOO-DOCCIA IN FLACONCINO  
DA ML. 41 AL GINSENG

GF04 6026

SAPONETTA GR. 25 IN ASTUCCIO DI  
CARTONCINO

GF08 3051

SET COTON FIOC CON BATUFFOLI DI  
COTONE

GF04 6541

SHAMPOO DOCCIA IN BUSTINA  
ML. 10 AL GINSENG

GF04 6015

SAPONETTA GR. 15 IN FLOW PACK

GF25 9006

POCHETTE IN PVC TRASPARENTE CON  
FINITURE - VUOTA

GF25 9007

POCHETTE IN PVC TRASPARENTE  
VUOTA





MA01 6560

### SGABELLO PVC 4 PIEDI

Sgabello in pvc quattro piedi colore bianco. Ingombro cm 35x35x39 h.



MA01 6661

### REGGI VALIGIA ABS CON SPONDINA

Reggi valigia in ABS con spondina. Ingombro 55x46x45 h.



SC01 1628

### REGGI VALIGIA CROMATO

Reggi valigia cromato senza spalla. Ingombro cm. 55x45x43 h.



SC01 0628

### REGGI VALIGIA OTTONATO

Reggi valigia ottonato senza spalla. Ingombro cm. 55x45x43 h.

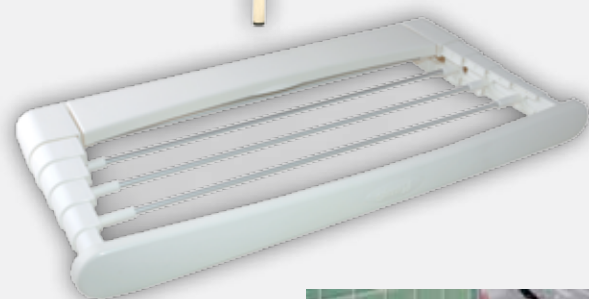

GM35 2670

### STENDIBIANCHERIA TELEPACK

Stendibiancheria in ABS ed alluminio, fissaggio a parete. Adatto per interni ed esterni (terrazzi, balconi, ecc.), con chiusura telescopica. Ingombro cm. 70x14,5x6 h.







# DEODORANTI SANIFICANTI INSETTICIDI



ES01 6856

### 1 - AUTOJANITOR

Erogatore elettronico per sistema automatico di sanificazione dello scarico wc e urinatoio e profumazione degli ambienti con 3 programmazioni (15 giorni - 30 giorni - 60 giorni). Realizzato in ABS. Ingombro cm. 11,5x4,5x24 h.



ES01 6850

### 2 - AUTOJANITOR BIOGIENE

Erogatore elettronico per sistema automatico di sanificazione dello scarico wc e urinatoio e profumazione degli ambienti con 3 programmazioni (15 giorni - 30 giorni - 60 giorni). Realizzato in ABS. Ingombro cm. 11,5x4,5x24 h.



ES11 0092

### 3 - EXPRESSION

ES11 0094

### 4 - VIBRANT SENSE

ES11 0090

### 5 - CELEBRATION

ES11 0091

### 6 - BIOFLUSH - SENZA PROFUMO

Flaconi ricarica per AUTOJANITOR ml. 610.



ST01 6852

### 1 - SANITYZER ACCIAIO

Erogatore sistema venturi di sanificazione dello scarico wc e urinatoio. Installazione a tubo. Realizzato acciaio inox. Ingombro cm. 10x5,5x20 h.

ST11 0080

### 2 - PASTIGLIE RICARICA SANITYZER

Ricarica solida profumata durata 2 mesi circa 4000 scarichi (confezione da 6 pastiglie). Per SANITYZER.



AL11 0086

### PASTIGLIE URINATOIO BIO BLOK

Pastiglie enzimatiche profumate inebitrici di cattivi odori per urinatoio. Confezione da 20 pastiglie.



IN11 0087

### BIOBLOC CON GABBIETTA

Gabbietta deodorante colorante schiumogeno per wc ad immersione gr. 80 (confezione da 12 pezzi).



NF06 2606

### DEOBLOC

Deodorante colorante schiumogeno per wc ad immersione. Confezione da 12 blister da 4 pastiglie da gr. 45.



ES01 9952

### PUMP SPRAY

Vaporizzatore automatico per deodorazione ambientale. Funzionamento a batteria per deodoranti in flacone da ml. 310. 5 regolazioni possibili, da 5 a 25 minuti. Possibilità di scelta tra funzionamento 24h oppure giorno o notte. Realizzato in ABS. Ingombro cm. 11x4,5x24 h.



ES01 7703

### 1 - NEUTRALLE EXPRESSIONS ML. 310

ES01 7707

### 2 - NEUTRALLE INSPIRATIONS ML. 310

ES01 7705

### 3 - NEUTRALLE ILLUSIONS ML. 310

Deodoranti liquidi in flacone da ml. 310 per utilizzo in PUMP SPRAY. Senza gas FREON. Confezioni da 6 flaconi.



PR01 9950

### BASIC

Vaporizzatore-diffusore ABS per insetticida e deodoranti spray senza propellenti. Possibilità di scegliere 3 temporizzazioni (8, 16 e 24 minuti). Funziona con batteria alcalina da 9 volts. Ingombro cm. 11x8,5x28,3 h.



PR01 9955

### NEW BASIC - PROGRAMMABILE

Vaporizzatore-diffusore in ABS programmabile per insetticida e deodoranti spray, senza propellenti. Possibilità di scegliere 3 temporizzazioni (8, 15 e 28 minuti). Funziona con batteria alcalina da 9 volts. Ingombro cm. 10x8,5x27,5 h.



1



2



3

PR05 7360

1 - AEROSOL  
INSETTICIDA

PR05 7364

2 - AEROSOL  
ANTITABACCO

PR05 7362

3 - AEROSOL  
BATTERICIDA

PR06 7384

4 - AEROSOL  
DAVANIA



4



5



6

PR06 7380

5 - AEROSOL  
FRUIT DE LA PASSION

PR06 7382

6 - AEROSOL  
CITRON

PR06 7378

7 - AEROSOL  
CARISSIMA



7



8



9

PR06 7374

8 - AEROSOL  
PANDARA

PR06 7372

9 - AEROSOL  
HERMANO

PR06 7376

10 - AEROSOL  
EAU ESSENTIELLE



10



11



12



13

PR06 7370

11 - AEROSOL  
NOTE VERTE

OR05 5368

12 - AEROSOL  
ECOSOL

OR05 5367

13 - AEROSOL  
PINAMOX

Senza gas FREON.  
Confezione da 6 bombole da ml. 400.



ST01 8800

### STEIN AIR RICO

Diffusore abs elettronico con fotocellula per profumazione ambienti. Dotato di bicchiere contenitore per profumo FRESH 6. Possibilità di scegliere 3 temporizzazioni (10, 2 e 30 minuti) per l'azionamento della ventola. Ingombro cm. 8,5x9x18 h.



ST06 8615

### FRESH 6 DEODORANTE TROPICAL PER RICO

Ricarica deodorante liquido per STEIN AIR RICO da inserire nel bicchiere-contenitore in dotazione all'apparecchio. Durata 2 mesi circa. Confezione blister da 6 ricariche.



OR01 9601

### AIR FREE

Vaporizzatore-diffusore in ABS per insetticida e deodoranti. Possibilità di regolazione a 7/15/30 minuti e con l'ausilio di una fotocellula 12 / 24 h. funziona con batteria alcalina o ricaricabile AA. Ingombro cm. 8x7,5x19,8 h.



OR01 9600

### X MATIC

Vaporizzatore-diffusore in ABS per insetticida e deodoranti. Possibilità di regolazione a 8/15/30 minuti. Funziona con batteria alcalina 1/2 torcia. Ingombro cm. 13x8,5x18 h.



OR01 9650

### MASTER MATIC

Vaporizzatore per deodorante e insetticida automatico con funzionamento a corrente elettrica temporizzato 8/15/30 minuti. Realizzato in ABS. Ingombro cm. 13x8,5x18 h.



OR05 5366 1 - DISTAIR INSETTICIDA

Insetticida a base di piretro 4% flaconi da ml. 250 (confezione da 6 flaconi).

CO05 5312 2 - PYREMATIC

Insetticida a base di piretro 6% flaconi da ml. 250 (confezione da 6 flaconi).

OR05 5362 3 - PINAMOX INSETTICIDA

Insetticida a base di piretro 8% flaconi da ml. 250 (confezione da 6 flaconi).



PR06 6208 1 - FRUIT ROUGES

PR06 6204 2 - DAVANIA

Deodorante spray in flacone da ml. 250 per AIR FREE e X MATIC. Confezione da 6 flaconi.



OR06 5363 FELCE SPRAY

OR06 5370 LAVANDA SPRAY

OR06 5380 RUBINO

OR06 5384 CARAIBI

OR06 5386 AMBRA

OR06 5382 GARDENIA

Deodorante spray in flacone da ml. 250 per AIR FREE e X MATIC. Confezione da 6 flaconi.



J006 5380

**PACO RABANNE**

J006 5382

**EGOIST**

Deodorante spray in flacone da ml. 250 per X MATIC. Confezione da 4 flaconi.



PR01 9800

**GAMMA**

Colonna profumante programmabile. Vaporizzatore per grandi ambienti. Ingombro cm. 35x45x65 h.

PR06 9824

**1 - DEODORANTE ETÈ EN PROVENCE**

PR06 9820

**2 - DEODORANTE DAVANIA**

Deodorante in lattina per GAMMA colonna profumante. Contenuto ml. 155 (confezione da 6 lattine).



1

2

KH06 0116

**GLOBAL PARFUM**

Essenza di profumo persistente per toilette flaconi da lt.1 (confezioni da 6 flaconi).



IN06 0173

**1 - CHIMI DEO MAGNOLIA MIMOSA**

IN06 0175

**2 - CHIMI DEO VANIGLIA SANDALO**

Deodorante a lunga persistenza con azione detergente. Cartone da 6 flaconi da ml. 500 con 6 spruzzini.







PR06 7520

### STROMBOLI NEUTRALIZZA ODORI

Bomboletta spray neutralizza odori ml. 500 (confezione da 6 bombolette).



PR06 7510

1 - STROMBOLI FLEUR DE FIGUIER

PR06 7500

2 - STROMBOLI DAVANIA

PR06 7530

3 - STROMBOLI COLOMBE D'OR

PR06 7525

4 - STROMBOLI ANTITABACCO

Bombolette spray profumate ml. 500 (confezione da 6 bombolette).

73



DE06 2603

### DEONET WC

Deodorante solido per wc (confezioni da 10x3 totale 30 pezzi).



NF06 2106

### DEOGEL

Deodorante profumato (3 profumazioni) in gel da gr. 150 (confezioni da 36 pezzi).



PR06 7610

#### VAPO LUX ORANGE

Deodorante manuale per ambiente in flacone da ml. 150 con erogatore ecologico (scatole da 2 flaconi in vetro).



PR06 7604

#### VAPO LUX POMELOS

Deodorante manuale per ambiente in flacone da ml. 150 con erogatore ecologico (scatole da 2 flaconi in vetro).



PR06 7600

#### VAPO LUX CAMEL

Deodorante manuale per ambiente in flacone da ml. 150 con erogatore ecologico (scatole da 2 flaconi in vetro).



PR06 7606

#### VAPO LUX VANILLE CANELLE

Deodorante manuale per ambiente in flacone da ml. 150 con erogatore ecologico (scatole da 2 flaconi in vetro).



PR06 7602

#### VAPO LUX DAVANIA

Deodorante manuale per ambiente in flacone da ml. 150 con erogatore ecologico (scatole da 2 flaconi in vetro).



PR06 7608

#### VAPO LUX FRUIT ROUGES

Deodorante manuale per ambiente in flacone da ml. 150 con erogatore ecologico (scatole da 2 flaconi in vetro).



BE06 1231

### AIR FLOR COCKTAIL FRUIT

Deodorante spray in flacone da ml 300.  
Confezione da 6 flaconi



BE06 1212

### AIR FLOR FIORI DI BOSCO

Deodorante spray in flacone da ml 300.  
Confezione da 6 flaconi



BE06 1201

### AIR FLOR LAVANDA E ORCHIDEA

Deodorante spray in flacone da ml 300.  
Confezione da 6 flaconi



BE06 1237

### AIR FLOR MUSCHIO BIANCO

Deodorante spray in flacone da ml 300.  
Confezione da 6 flaconi